

LASER PEGS®

The Ultimate Construction Toy For Kids®

NATIONAL GEOGRAPHIC™
SPACE

Ages 5 +

24 Models+
ANY CREATION YOU CAN BUILD

LIGHT UP

CONSTRUCTION SET INCLUDES:

- 36 Laser Pegs®
- 125 Construction Parts
- Laser Pegs® Peg Cord
- Triangle Power Base
- Instruction Manual

Requires 3-AA Batteries

Batteries NOT Included

WARNING: CHOKING HAZARD—Small parts. Not for children under 3 yrs. Do not submerge in water.

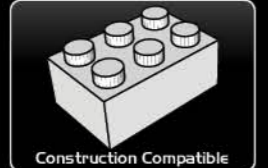

Compatible with other construction kits

EN71, RoHS COMPLIANT

This product complies to all safety requirements of ASTM F 963

MODEL INSTRUCTIONS

All additional model instructions can be downloaded at www.LaserPegs.com

Laser Pegs® Parts List

There is No LED In The 90 Degree Peg

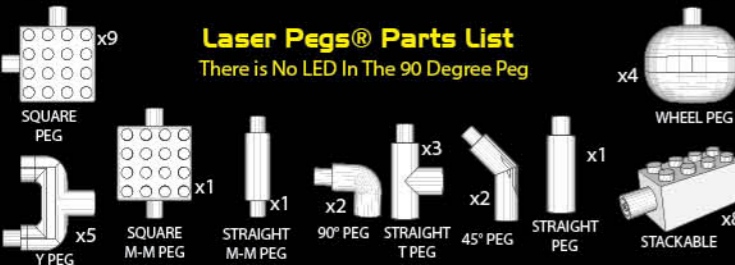

Each Laser Peg® is color coded on the circuit board inside each shape. There is No LED In The 90 Degree Peg.

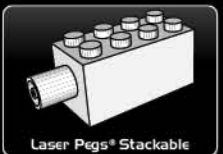

Laser Pegs® link that allows you to connect to other construction kits.

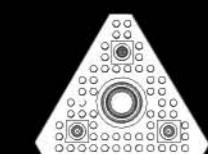

Sound Activated Triangle Power Base

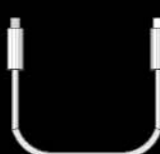

Laser Pegs® Peg Cord

Construction Parts List

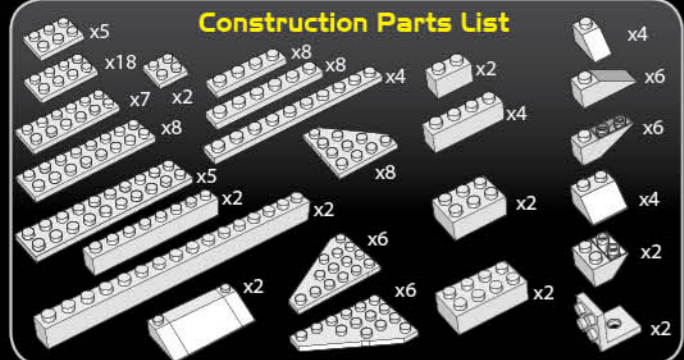

www.LaserPegs.com

This manual is copyright and cannot be reproduced or used online without Laser Pegs® Ventures LLC permission. Copyright 2014 © All Rights Reserved US Patent #7,731,558 Additional Global & Multiple Patents Pending. Laser Pegs® Ventures LLC. 8304 Consumer Ct Sarasota FL. 34240. Contact: Support@LaserPegs.com

Connecting Pegs

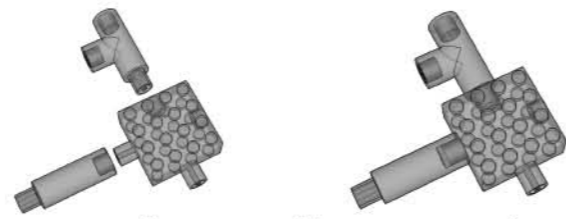

To construct with Laser Pegs®, slide two pieces together to form a connection. Slide each piece on and off smoothly. The 90° Pegs are essential to construction but they DO NOT LIGHT UP.

Environmental Phenomena

* The unit may malfunction if subjected to radio-frequency interference. It SHOULD revert to normal operation when the interference stops. If not, it may become necessary to turn the power off and back on, or remove and reinstall the batteries.

* In the unlikely event of an electrostatic discharge, the unit may malfunction and lose memory, requiring the user to reset the device by removing and reinstalling the batteries.

Push Red Power Button to turn on/off

Push Red Power Button to cycle through 4 different light settings.

SOUND/ON/FLASH/FLASH FASTER

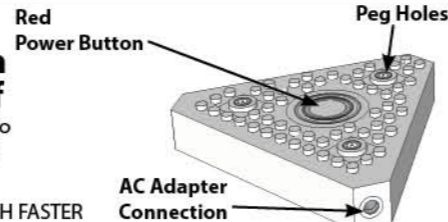

WARNING: STROBE LIGHTS MAY CAUSE SEIZURES

Replacing Batteries

1. Remove the three (3) screws.
2. Place three (3) AA batteries in the correct position - as displayed inside the Triangle Power Base.
3. Reassemble the Triangle Power Base.
4. Replace the three (3) screws.
5. Push RED Power Button to turn on!
6. Do not mix old and new batteries.
7. Do not mix alkaline, standard (carbon-zinc), or rechargeable (nickel-cadmium, NiMH) batteries!
8. Exhausted batteries are to be removed from the Triangle Power Base.
9. Never connect more than 200 Laser Pegs®
10. Non-rechargeable batteries are not to be recharged.
11. Rechargeable batteries are only to be recharged under adult supervision.
12. Rechargeable batteries are to be removed from the toy before being recharged.
13. Batteries are to be inserted with the correct polarity.
14. The supply terminals are not to be short-circuited.
15. DO NOT THROW BATTERIES INTO FIRE!

Remove the 3 Phillips head screws

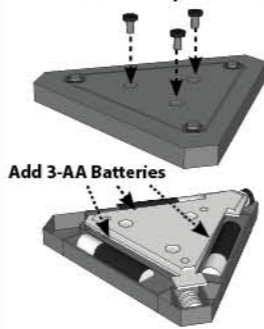

Add 3-AA Batteries

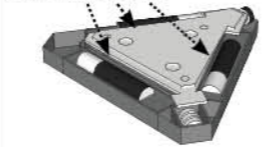

Remove the three Phillips head screws with a 4mm screw driver.

Requires (3AA) Batteries

Please dispose of batteries properly as per state and local regulations.

Using an AC Adapter

Remove all batteries from Laser Pegs® power base before using the 5-volt AC adapter.

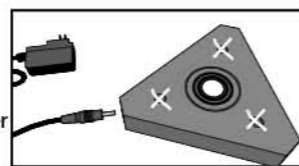

When using an AC Adapter, NEVER place the adapter plug into the Triangle Power Base top peg holes.

*To avoid short-circuits, keep metal objects and other unauthorized materials from obstructing the peg holes.

Never connect more than 200 Laser Pegs® when using a 5-volt (2000mA) AC Adapter.

The AC adapter and the Triangle Power Base are to be regularly examined for damage to the cord, plug, enclosure and other parts, and in the event of such damage, they must not be used until the damage has been repaired.

WARNING! Each Laser Peg® draws current from the batteries. Therefore, the more pegs you use, the quicker you will deplete your battery power! As the power weakens, the current will slowly fail and some Laser Pegs® will illuminate (typically the reds and yellows) and some won't. When the Laser Pegs® dim the Laser Pegs® are not broken, they just need stronger batteries or an AC Adapter. You have 3 simple options...

1. Use a 5-volt AC Adapter -available from www.LaserPegs.com
2. Change the batteries.
3. Use high quality batteries. They will last a little longer, but they will still deplete rapidly the more laser pegs you connect!

DO NOT SUBMERGE IN WATER

MINI SPACE SHUTTLE: The space shuttle was the first reusable spacecraft and was able to land like a commercial airliner on a runway, instead of in the ocean like its predecessor, the space capsule. While in Earth's orbit, space shuttles traveled so fast crews could see sunrises and sunsets every 45 minutes.



MINI SPACE SHUTTLE

Model Difficulty Level

2

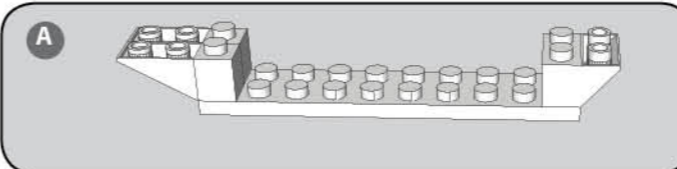
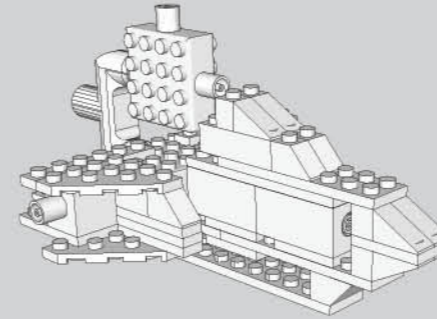

STEP 1

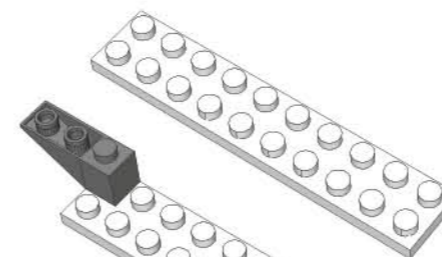

STEP 2

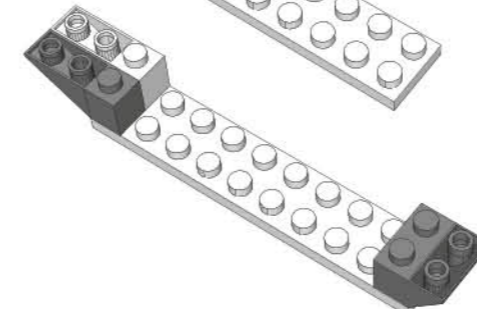

STEP 3

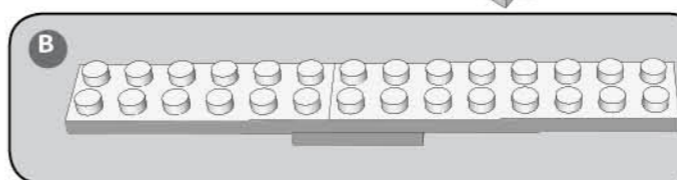

STEP 4



STEP 5



STEP 6

COMBINE

A B

STEP 7

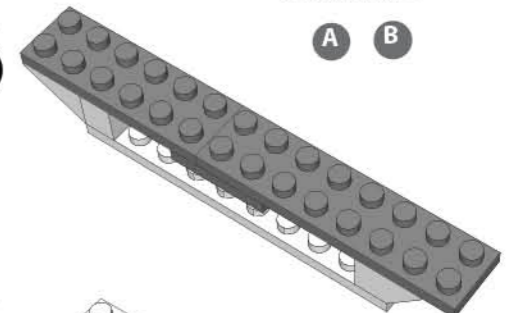

STEP 8

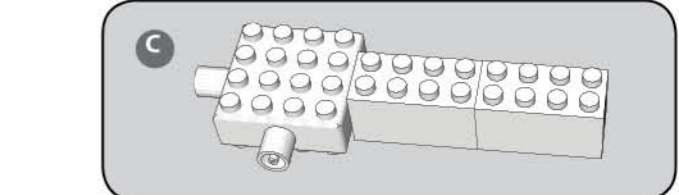
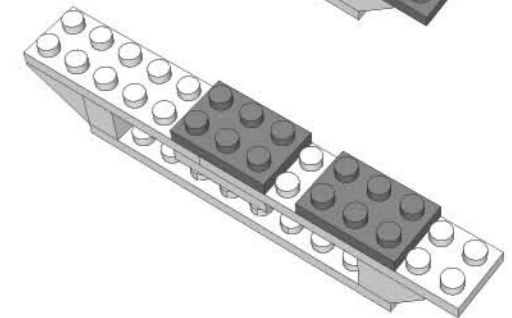

STEP 9

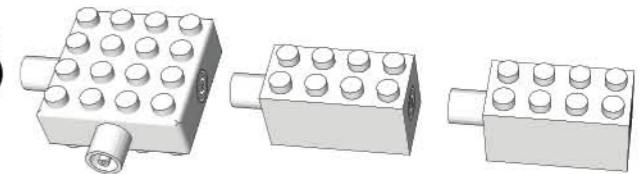

COMBINE

C

STEP 10

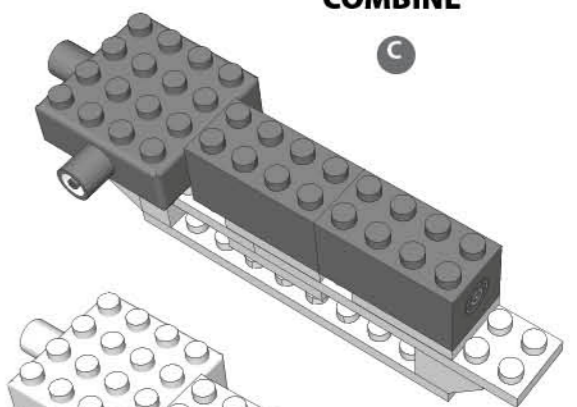

STEP 11

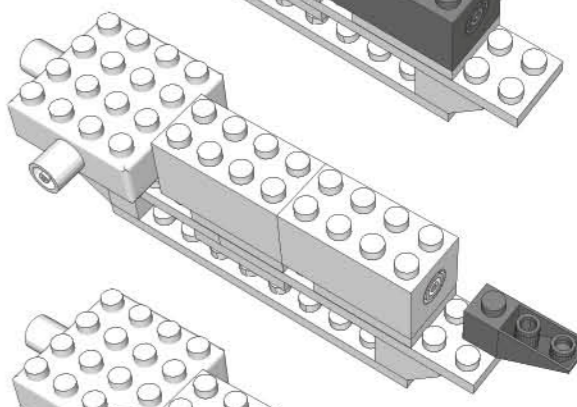

STEP 12

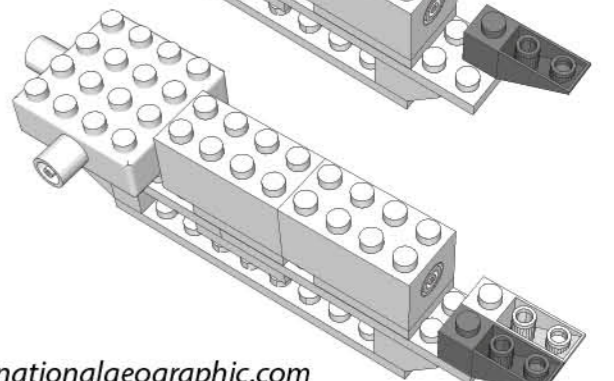

Laser Pegs® CARES
Questions? Comments?
For additional compliance info:
1-866-432-3735
Contact: Support@LaserPegs.com

kids.nationalgeographic.com

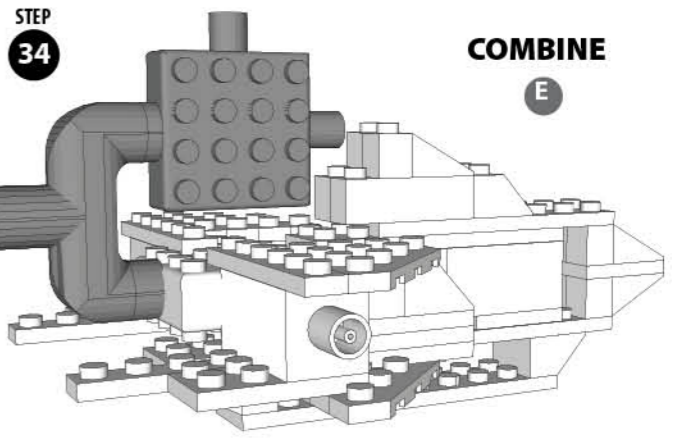
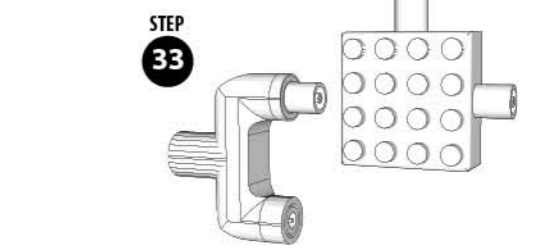
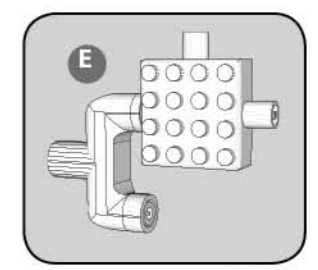
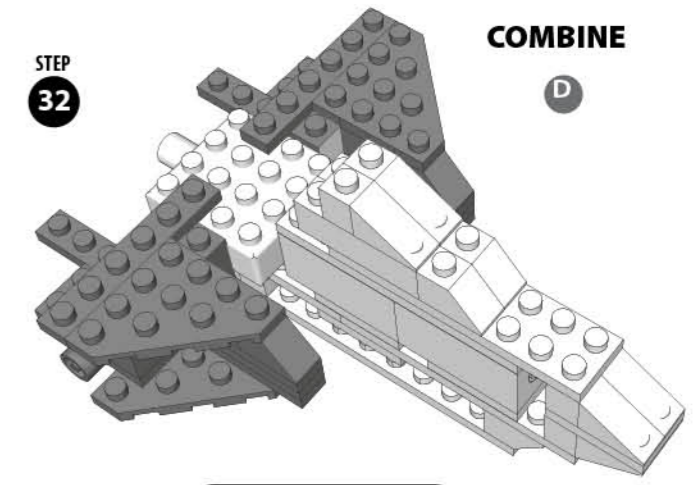
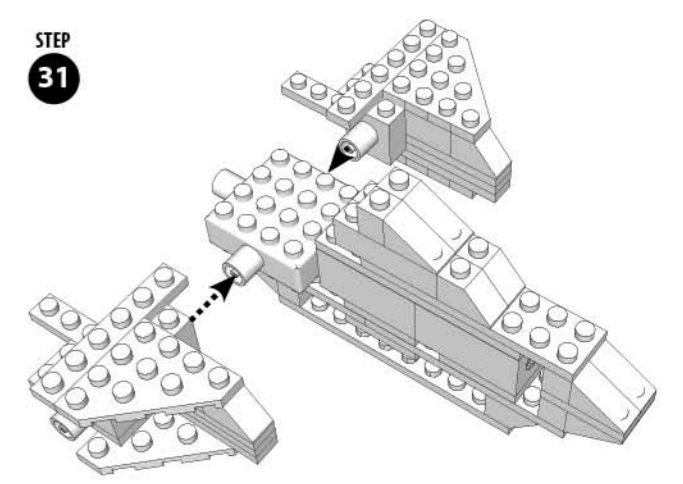
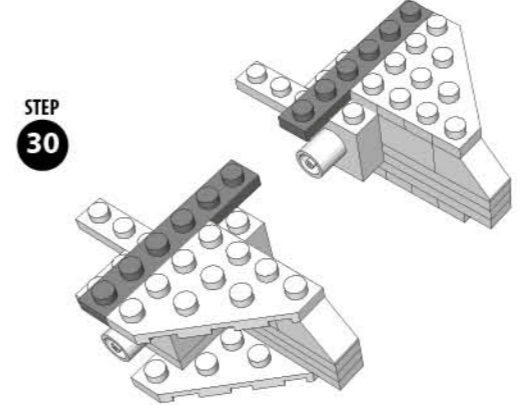
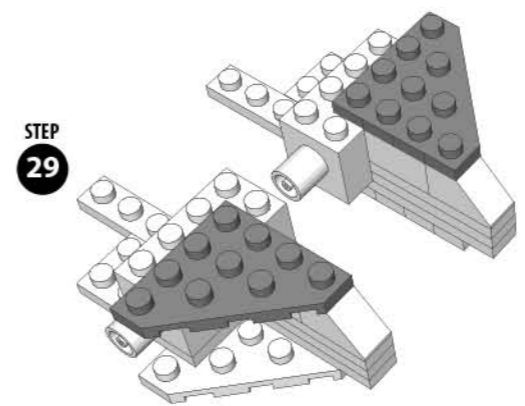
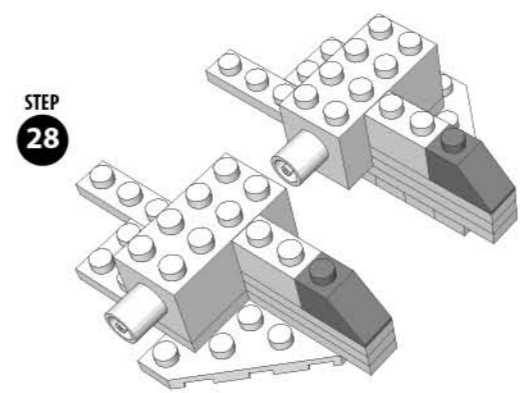
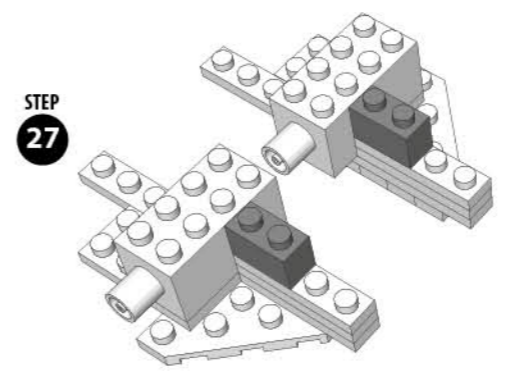
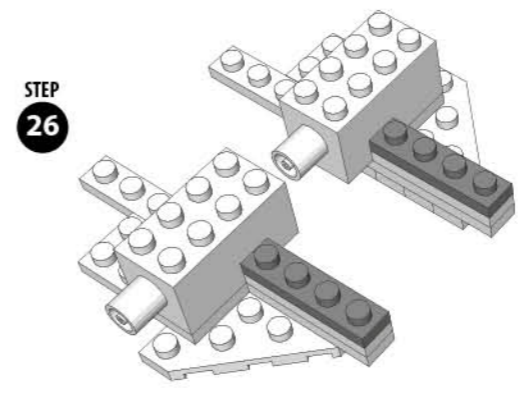
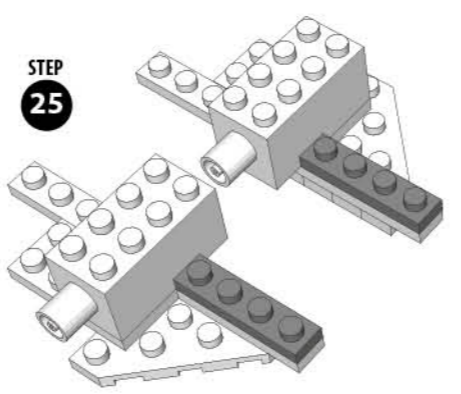
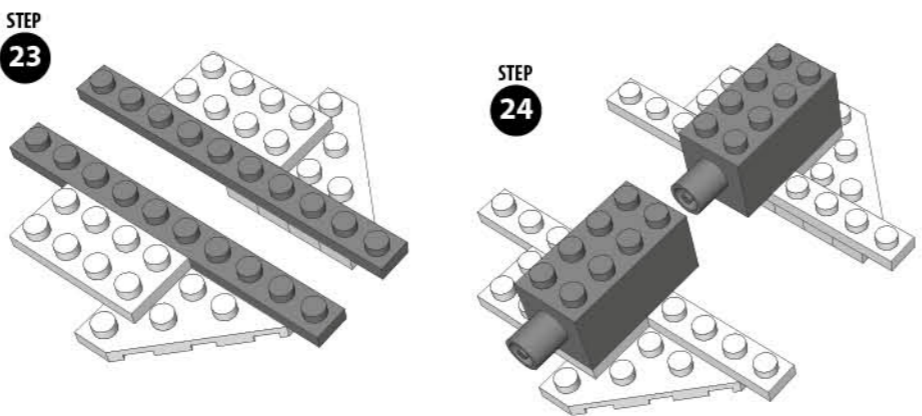
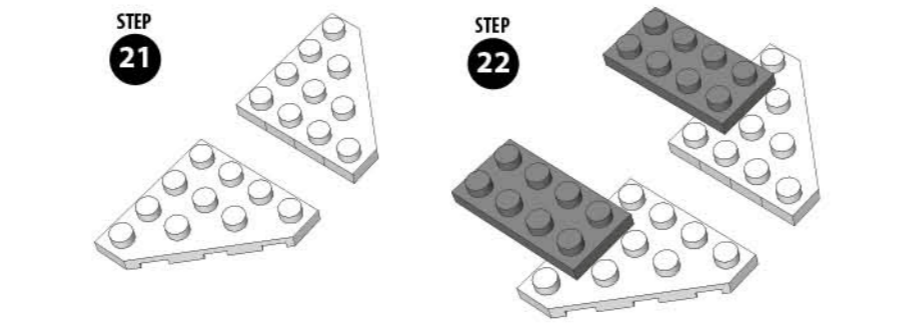
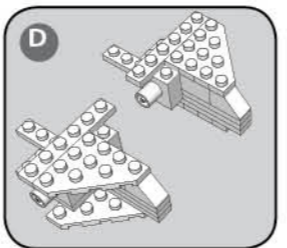
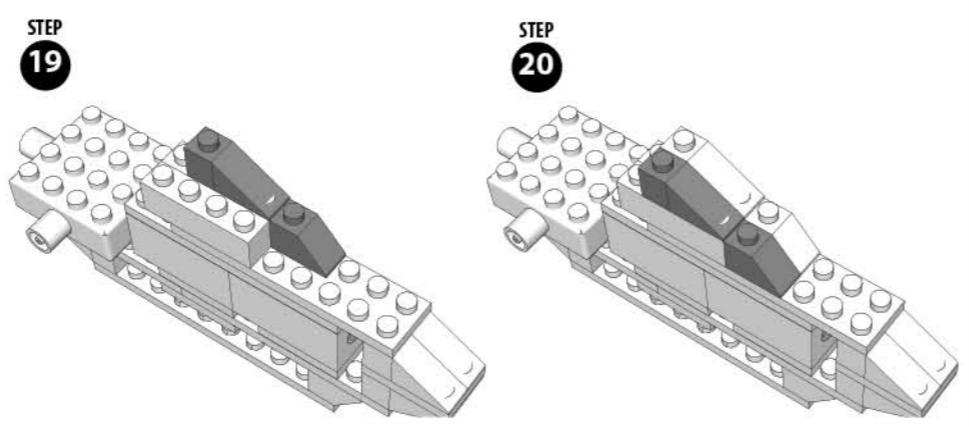
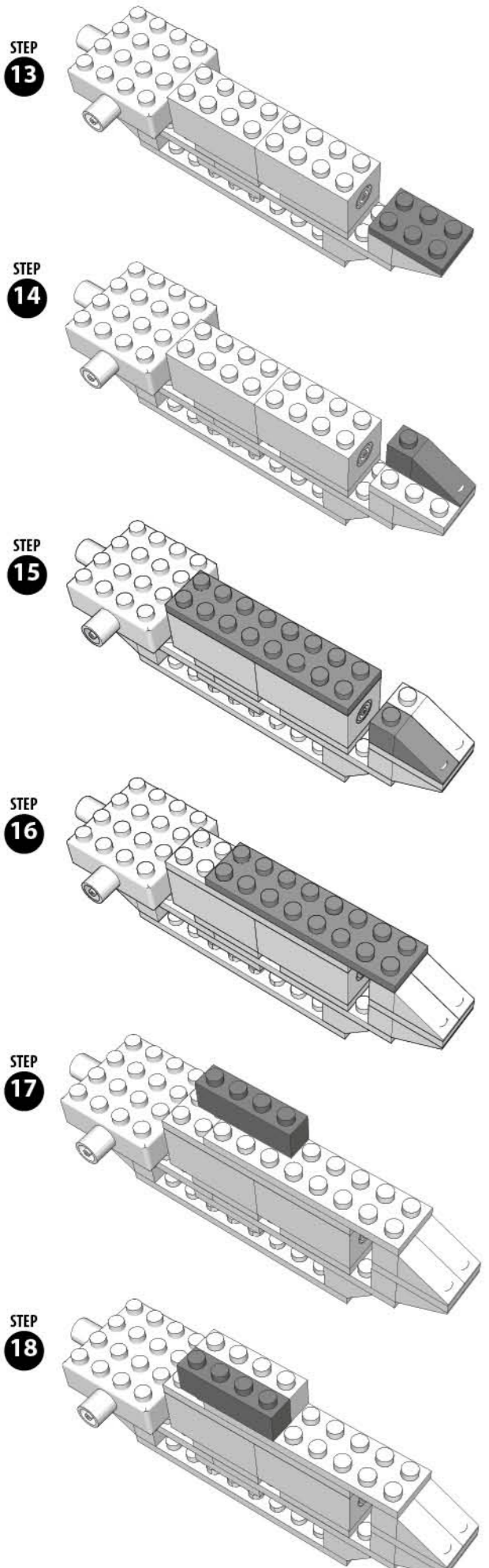

ATTACH MODEL TO THE TRIANGLE POWER BASE WITH THE PEG CORD

© 2014 National Geographic Society

NATIONAL GEOGRAPHIC KIDS and Yellow Border Design are trademarks of the National Geographic Society, used under license. All rights reserved.



National Geographic's net proceeds support vital exploration, conservation, research, and education programs.

MADE IN CHINA

www.LaserPegs.com
Copyright 2014© All Rights Reserved Global & Multiple Patents Pending.
US Patent #7,731,558